

The logo for YEELM features a stylized black silhouette of a hand holding several black circles of various sizes, resembling a bouquet of flowers or a cluster of lights. The circles are arranged in a roughly circular pattern above the hand.

YEELM™

ENTTEC LED MAPPER



Effortless LED Mapping



Contents

Key Features.....	3
Computer Requirements.....	3
Licenses.....	5
Software Updates.....	5
Definitions.....	6
Getting Started With LED Strips	7
Quick Overview	8
ELM Tour	9
Home Screen.....	9
New Stage Dialog.....	10
Stages.....	11
Status Indicator.....	12
Stage Syncing.....	12
Stage Merging and Layering	13
Edit Zone.....	14
Strips Tab.....	16
Stage Tab.....	23
Testing Tab.....	25
Stages Manager	27
Media Library	28
Schedules.....	30
Live Mode.....	32
Settings.....	34
Project.....	34
Art-Net.....	34
sACN	35
KiNet.....	36
Audio	36
Time	36
License.....	37
Remote Control	37
Troubleshooting	43
EULA.....	46



Key Features

ELM is all about displaying your video content on LED fixtures of any shapes, in the most convenient way.

- ✓ Vector-based editor
- ✓ 2048 DMX universes
- ✓ Art-Net, sACN, KiNet
- ✓ Scheduled playlists
- ✓ Remote control via DMX, OSC and HTTP
- ✓ HD video + audio playback
- ✓ Spout + NDI integrations for live video inputs
- ✓ Stream LED rendering to visualizers via NDI
- ✓ DVI outputs for projectors and TVs
- ✓ Over 100 high quality animations included
- ✓ Extreme reliability for permanent installations
- ✓ RGB, RGBW, RGBA, RGBAW and white fixtures
- ✓ 16-bit color support



Computer Requirements

ELM is compatible with Windows 7 and up, including Windows 8 and 10. 32-bit and 64-bit versions are provided to suit your OS.

The .Net 4.6 framework is required and you'll be prompted to install it if needed.

Minimum

- Windows 7+, 2 GHz Intel i5, 2 GB RAM
- NVIDIA GeForce 600 series or Intel HD Graphics 5500, released after 2013 with OpenGL 3.3 support

Recommended

- Windows 8 or 10, 2.4 GHz Intel i7, 8 GB RAM
- NVIDIA GeForce 900 series or NVIDIA 10 series or better
- SSD hard drive



The computer requirements depend on your media type. For example, playing multiple HD videos requires a good computer. A rule of thumb is you can play one full HD video @ 30fps for each 2 GHz CPU core. So if you have an Intel i7 4 GHz (4 cores), you should be able to play 8 full HD videos. Increasing the playback speed to 2x means the fps also increases two times and the number of videos you can play simultaneously is roughly divided by two.

The next table shows the approximate number of videos you can play simultaneously at 30 fps depending on your CPU.

CPU Speed x Cores	Full HD Videos	HD Videos	640x360 Videos
2 GHz x 2	2	4	10
3 GHz x 2	3	6	15
4 GHz x 2	4	9	20
2 GHz x 4	4	9	20
3 GHz x 4	6	13	30
4 GHz x 4	8	18	> 40
3 GHz x 8	10	22	> 40

For live video performances, when you want to change the playback speed and go up to 10x, the recommended video resolution is 640x360.

For the DMX output, a 1 Gigabit network should be able to handle 2048 universes @ 44fps. For more universes, a supplementary network card and a second Ethernet network are recommended.



Licenses

The ELM's licensing system has been built with reliability and simplicity in mind. Basically, once a computer has been activated, it will be able to run ELM until it dies. No internet connection required, so you can be completely off the grid without worrying about the license.

Each license is registered to one individual or company and covers the activation of the software on a certain number of computers, so long as ELM is running on one computer at a time. For example, you can activate a show and a backup computers but only one computer can run ELM at a time.

The license is a simple file that you import once. No hardware dongles are needed, eliminating a whole range of tricky problems: broken dongle, lost dongle, dongle suddenly not detected in the middle of the show, etc.

The license is linked to your computer's CPU and motherboard. You can upgrade any other components and reinstall the OS without invalidating your license.

A license isn't transferrable, meaning once your computer stops working, you can only activate ELM on another computer if you still have activations left. Use this online form to activate a computer: <https://www.enttec.com/my-account/license-registration/>.

To get more DMX universes, you can activate multiple licenses on the same computer. The DMX universes of all licenses will be added.

Software Updates

You always have access to the latest and greatest version, free of charge.

To get the updates, go in the Settings/About menu and press the check for updates button. Alternatively, you can go on the Enttec's website and download the latest version.

<https://www.enttec.com/products/controls/pixel-control-controls/software-pixel-mapping/>



Definitions

Art-Net: Protocol to transmit DMX over a standard Ethernet network. Designed by and Copyright Artistic Licence Holdings Ltd.

DMX: One of the most common protocols used to control lighting fixtures. The full name is DMX512, which stands for Digital Multiplex.

DMX universe: Represents 512 DMX channels. Enough for 170 RGB LEDs (1 LED takes 3 channels, one for red, one for green and one for blue).

FPS: Frames per second. It refers to an output rate for video or DMX.

KiNet: Protocol to transmit DMX over a standard Ethernet network. Designed by Color Kinetics and acquired by Philips.

LED strip/string: Lighting fixture that may contain many LED elements and have a certain physical length. Some LED strips are flexible and can be bent to create curves and all kind of shapes. ELM handles all lighting fixtures as if they were strips, giving you a lot of positioning flexibility.

Mapping: Mechanism used to associate a pixel from a media source to a specific lighting fixture element.

Media: Any type of visual content, including videos and pictures.

Network Device Interface (NDI): Protocol to stream live videos over the network. Developed by NewTek - <http://NDI.NewTek.com>.

Open Sound Control (OSC): OSC is a network protocol allowing multimedia apps to communicate. ELM can be remotely controlled via OSC.

RGB, RGBW, RGBA, RGBWA: Various color components: red, green, blue, white and amber.

sACN: Protocol to transmit DMX over a standard Ethernet network - like Art-Net. More specifically, the E1.31 subset is used for DMX control. Developed by ESTA.

Spout: Real-time video sharing framework for Windows. Similar to Syphon on Mac. <http://spout.zeal.co/>

Stage: A mapping surface defining the position of the media placeholder and the position of lighting fixtures.



Getting Started With LED Strips

ELM can control any DMX-enabled lighting fixtures – not only LED strips. This is made possible because ELM outputs industry standard protocols like Art-Net, sACN and KiNet. This means that ELM can control traditional DMX dimmers and any RGB, RGBW, RGBA and RGBAW lighting fixtures.

Controlling LED strips is a little bit different than traditional DMX fixtures. The main difference is that you need to use LED controllers to drive your strips. They replace the Art-Net nodes you use for traditional DMX fixtures. The LED controller receives DMX via Art-Net/sACN and converts to the special protocol the LEDs understand. Enttec offers the Pixelator which takes 48 DMX universes and controls up to 8160 RGB LEDs.

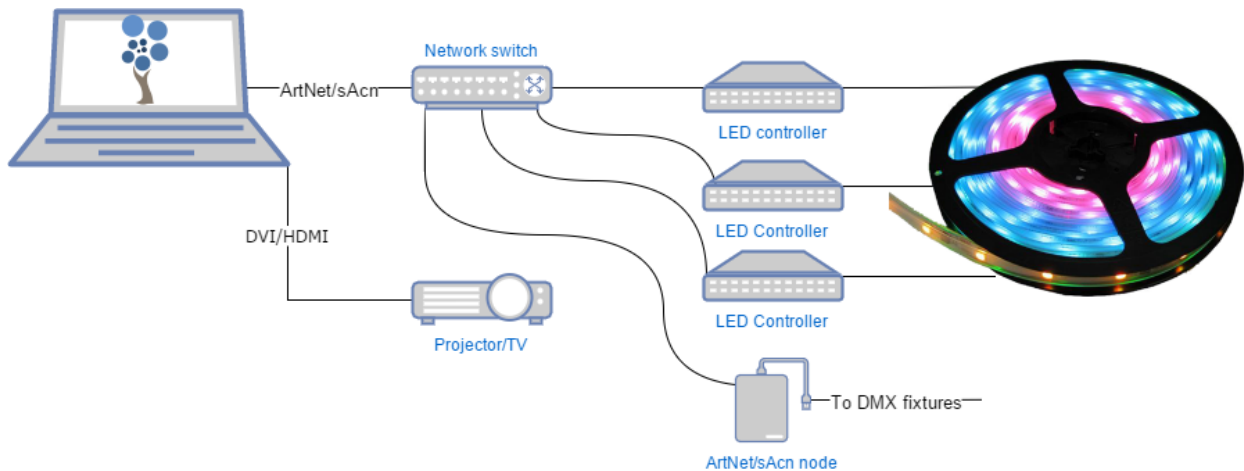

The next step is to get LED strips and DMX fixtures. Since there are many LED protocols out there, you need to make sure your LED controller fits with your LEDs. Common protocols for RGB LEDs are WS2811 and WS2812/B. For more information about getting compatible LEDs, contact your Enttec representative. Here's the Enttec Pixelator that can be used to control the Phero and Enttec LED tapes:





Quick Overview

ELM allows dividing your installation into multiple zones and layers called stages. You control the media content independently for each stage. Stages can overlap and they are merged (blended) to generate the final result. A common scenario is to create a stage spanning the whole installation to map media across the board. To enable precise control over specific zones, you create smaller stages inside the big stage. Then you activate these zones whenever you want. For example, in the installation below, we can play a video on the overall stage - which acts as the background layer - and when there's a special event, we activate the logo zone and make it flash.

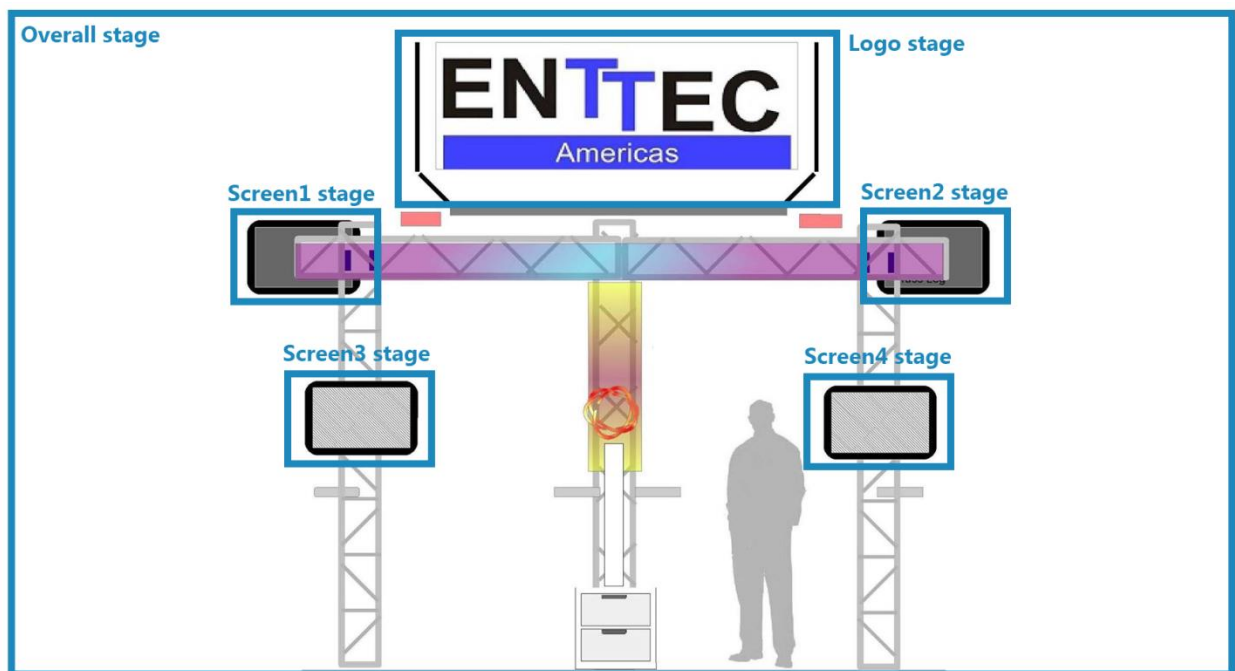

To represent your LED strips and DMX fixtures inside a stage, ELM has a powerful vector-based editor. This way, you can easily draw many types of shapes, including matrices, loops and curves. ELM computes the position of each LED based on your drawing.

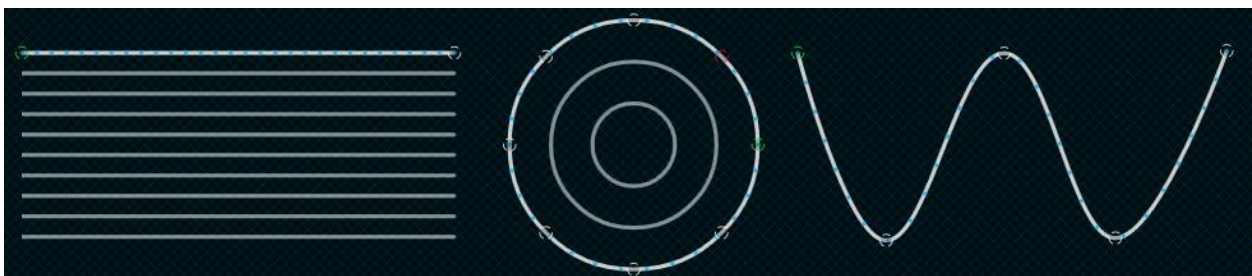



ELM Tour

Let's go over the main screens and controls of ELM.

Home Screen

Welcome! Start a new project or load an existing one. To see the keyboard shortcut keys, press the alt key.

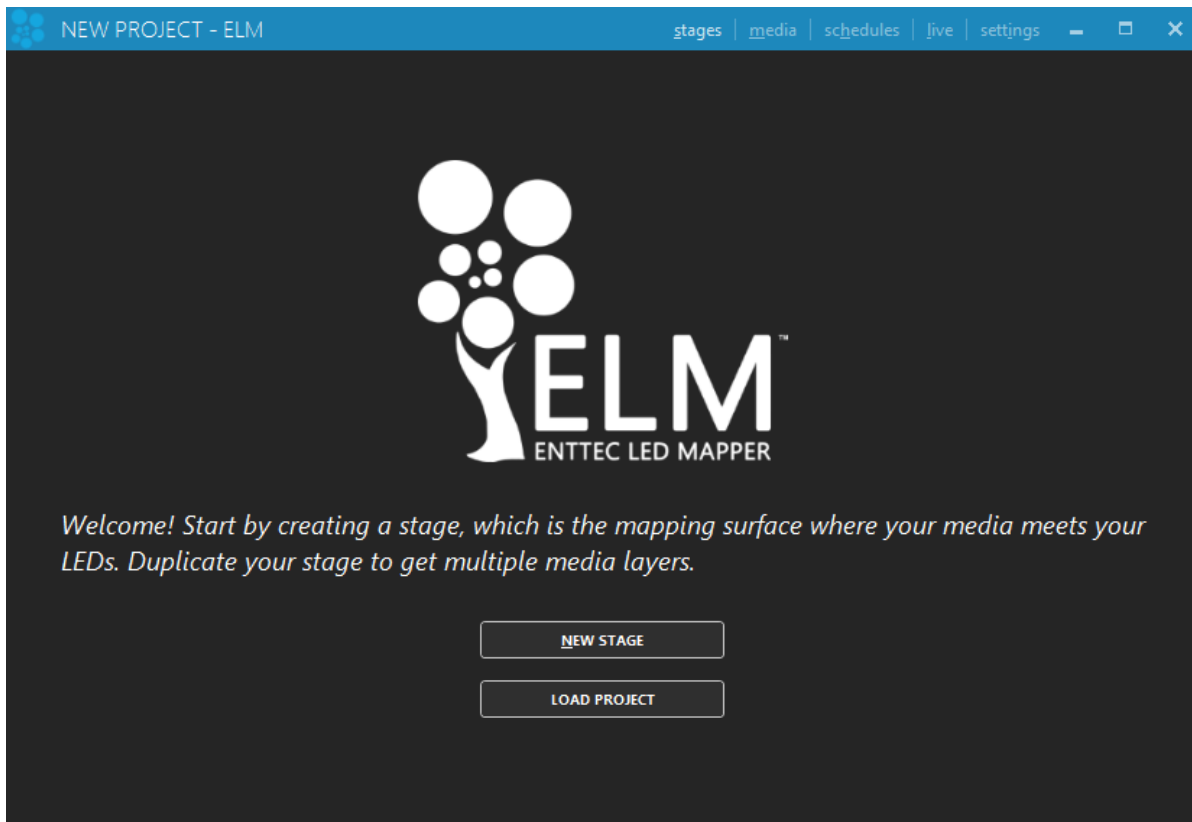

New stage (alt-N)	Creates your first stage and start the mapping process.
Load project (ctrl-O)	Loads an existing project.
Media (alt-M)	Goes to the media library.
Schedules (alt-H)	Goes to the schedules.
Live (alt-L)	Goes to the live panel.
Settings (alt-I)	Goes to the settings panel.



New Stage Dialog

A rule of thumb is to create a stage with dimensions respecting the aspect ratio of your media. Then you'll position your LED strips on it to create the mapping. For example, you can create a full HD stage - which has a rectangular aspect ratio - to fit your media sources, and then map a 20x20 square LED array on it.

You can easily change the dimensions later, so don't worry. The minimum recommended size is 320x180. Smaller than this size, you'll need to constantly work at a very high zoom level, which isn't very convenient. So it's better to use a higher size and let ELM scale your media.

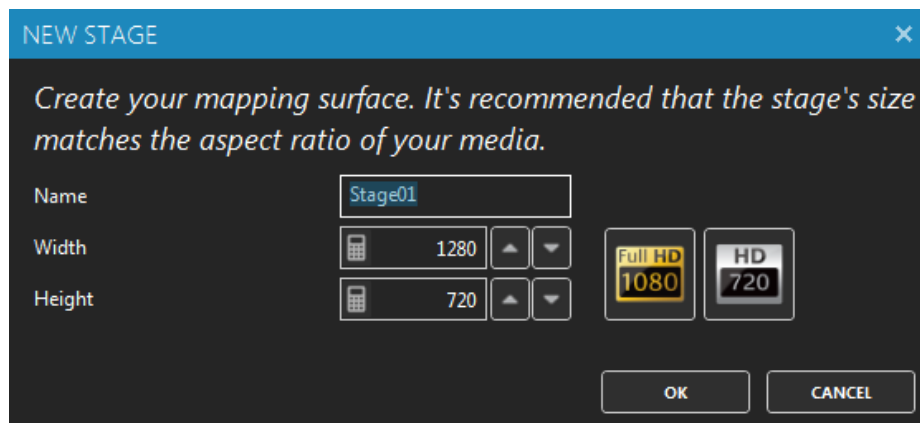

Name	The name of your new stage. Usually refers to its physical location.
Width, Height	The desired size in pixels for the mapping surface used to display media. This can be changed later without affecting the mapping.
Full HD, HD buttons	Presets for common media sizes. Full HD is 1920x1080 and HD is 1280x720.

To help you position the strips like they are in the real world, use a picture of your installation as the stage's background (see Stage Tab). No pictures handy? Use your phone's camera to get one!



Stages

Shortcut key: alt-S

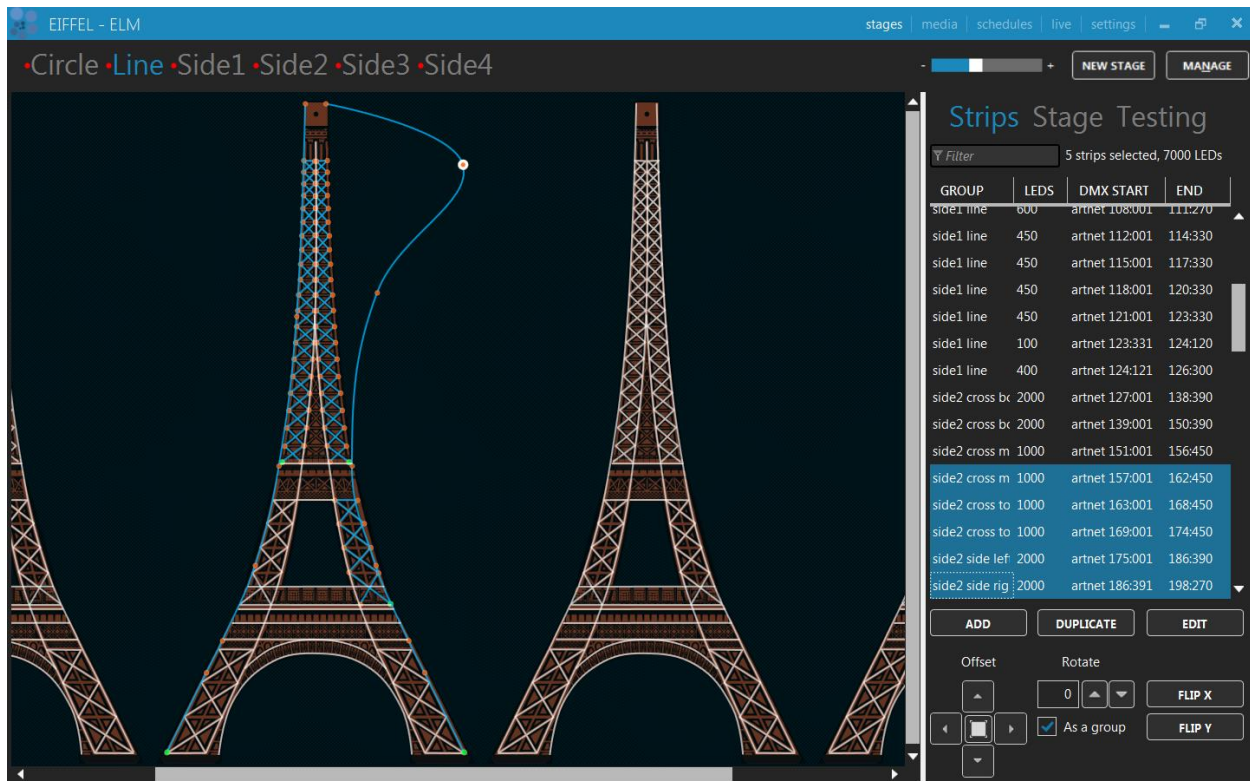

You can create as many stages as you want. Generally, you'll want an overall stage corresponding to the whole installation and multiple individual stages to target specific zones. The overall stage allows you to map content across the board. Then the other stages allow you to override specific parts of your installation whenever you want. You can select the current stage by clicking its name at the top.

Different effects may demand different mapping layouts. One goal of the mapping is to ease the content creation. So don't hesitate creating multiple stages with the same LED strips but positioned in different ways.



Status Indicator

At the left of the stage's name, a small indicator tells you the current control mode and its status. The activated status means a media is selected and the stage's intensity (see Live Mode) is greater than 0%.

• Stage	Manual control mode, stage deactivated.
Stage	Manual control mode, stage activated.
R Stage	Remote control mode, stage deactivated.
R Stage	Remote control mode, stage activated.
S Stage	Schedule control mode, stage deactivated.
S Stage	Schedule control mode, stage activated.
A Stage	The audio reactive mix mode is active.
T Stage	The testing mode is active.

Stage Syncing

All stages using the same media slot are considered to be synced. You can still change the individual stage output parameters like the intensity and the color filter, but the media content is the same on all synced stages. When applicable to the media type, the media playback speed is determined by the maximum speed of all stages using this media.

To play the same video file on multiple stages but at different speeds, load the video file in multiple media slots. Then use a different media slot for each stage.



Stage Merging and Layering

When multiple stages contain the same LED strips, a merge occurs following the order as shown in the Stages Manager. This allows creating complex visuals by layering multiple stages on top of each other. You can target specific zones by creating stages with only a subset of all strips or with parts of the strips outside the stage. A stage must be activated (a media is selected and the stage's intensity is greater than 0) otherwise it is considered to be transparent and will not be part of the merge.

The merge modes are:

Overwrite	Completely replaces the left stages. The right stage is fully opaque.
Multiply	Multiplies each pixel of the right stage with the corresponding pixel for the left stage. The right stage becomes a video mask.
Screen	The values of the pixels in the two stages are inverted, multiplied, and then inverted again. This yields the opposite effect to Multiply. The result is a brighter picture.
Overlay	Combines Multiply and Screen modes. The parts of the right stage where left stage is light become lighter, the parts where the left stage is dark become darker.
Darken	Takes the smallest color component for each pixel.
Lighten	Takes the largest color component for each pixel.
Difference	Subtracts the left stage from the right stage or the other way round, to always get a positive value.
Add	Adds pixel values of one stage with the other.
Subtract	Subtracts pixel values of the right stage to the left stage.
Black key	Shows the pixels of the left stage only where the pixels of the right stage are black. In other words, black pixels are transparent.
IntensityCrossFade	The stage's intensity determines its opacity level.
IntensityWhiteFade	The stage's intensity determines its opacity level in a white fade fashion, meaning that when the intensity is at 50%, both the current stage and the ones under are merged at full opacity.

To easily target specific zones of an installation, first create the overall mapping then select the strips corresponding to the individual zones and right-click in the strip list to access the "new stages from strips" menu.



Edit Zone

You can position your strips as they are in the real world or based on the effect you want to create with your media.

A strip has start (green) and end (red) control points indicating the direction of the patch. Multiple intermediate control points can be used to create various shapes. You can bundle multiple strips together to simplify the handling of complex shapes.

You can position parts of your strips outside the stage. In this case, the LEDs outside the stage will not be mapped. This is a common scenario when using the same strips in multiple stages and you want to target specific parts in each stage.



Select strips/Deselect all (ctrl-d)	Click a strip to select. Hold the ctrl key to add to the selection. Hold shift to use a selection rectangle and select all strips inside the rectangle. Press ctrl-a to select all strips and ctrl-d to deselect.
Move a control point	Click on a control point and drag it. Hold shift while dragging to align with the previous point.
Move selected strips	Right-click on a strip and drag it. Selected strips will follow.
Add a control point	Right-click on the stage (only one strip needs to be selected) or on a control point to use the context menu.
Delete a control point	Right-click on a control point and select the delete option.
Reverse the control point order	Right-click on the first control point (the green one) and



	select the “reverse points” menu item. The shape of the strip remains the same but the result is that the DMX addresses will be reversed. This is handy when the strip has been physically installed in the wrong direction.
Bundle/Unbundle strips (ctrl-b, ctrl-shift-b)	Select multiple strips and right-click on one of them in the Strip List. Then select the bundle menu item to create one element with all selected strips. You can unbundle the strips to edit or see the details.
Move around the stage	Click on the stage background and drag.
Zoom in/out (ctrl-plus, ctrl-minus, ctrl-0, ctrl+mousewheel)	Use the zoom control at the top. Zoom out when you want to offset the selected strips quickly. Ctrl-0 resets the zoom.
Show individual LED positions	When zoomed enough, the LEDs of the selected strips should be visible. They are the blue dots. Put your mouse over to see the LED number and its DMX address.
Copy/paste strips (ctrl-c ,ctrl-v)	Copy and paste the selected strips. You can paste the strips in a different stage.
Delete selected strips (ctrl-delete)	To delete the selected strips, use the ctrl-delete shortcut or right-click in the strip list and select the delete menu item.
Undo (ctrl-z), Redo (ctrl-y)	You can always use Undo and Redo while editing.



Strips Tab

Shortcut key: alt-P

Strip List

Strips Stage Testing

side1 19 strips, 4000 LEDs

GROUP		LEDS	DMX START	END
side1	cross bottc	300	artnet 000:001	001:390
side1	cross bottc	300	artnet 001:391	003:270
side1	cross midc	100	artnet 003:271	004:060
side1	cross midc	100	artnet 004:061	004:360
side1	arch small	100	artnet 004:361	005:150
side1	line	100	artnet 005:151	005:450

The strips for the current stage are shown in this list. Select one or multiple strips in the list to also select them in the edit zone. Right-click in the list for more options. You can click the column headers to sort. Type text in the filter box to filter based on the group names.

Use the group and sub-group fields wisely in order to use the filter box and quickly select the strips you want.

Add Strips Dialog (Quick Patching)

Shortcut key: alt-A

Quickly patch your strips and lighting fixtures to create arrays and any shapes you can imagine. Multiple LED types (or color types) are supported, including RGB, RGBW, RGBA, RGBAW/RGBWA and white (dimmers). Most color component orders (GRB, BGR, etc.) are supported. For lighting fixtures supporting high precision colors, 16 bit color depth can be used via the RGB16, GRB16, RGBA16, RGBW16 and White16 types. RGBWmax activates all channels (RGB+white) when white is needed for maximum brightness.



ADD STRIPS
✕

Number of strips ▲ ▼

LEDs per strip ▲ ▼

Type ▼

Shape ▼

Group

DMX protocol ▼

Start universe ▲ ▼

Start address ▲ ▼

LED address offset ▲ ▼

Break universe after ▲ ▼ ▼

Number of strips	The number of LED strips/fixtures you want to patch.
Patching direction 	For LED arrays, specify the way your strips are wired to let ELM automatically assigns the proper DMX addresses.
LEDs per strip	The number of LEDs per strip. Enter 1 to create a unique fixture.
Type	Also named pixel type. Corresponds to the color component order (RGB, BGR, GRB, etc.) and the capability (white only, RGBW, etc.). Many LED strips have the color components in a different order than red, green and blue. Usually, LED controllers have the option to reorder the color components but ELM can handle this for you.
Shape	Select a predefined shape to position your strips on the stage. For arrays, use lines. Use loop to create circles.
Group and sub-group	Use these two groups to tag your strips and quickly find them later. You can search for these keywords in the strip list's filter box.
DMX protocol	Select the output method for DMX: Art-Net, sACN or KiNet.



Start universe	The universe of the first strip to be patched.
Start address	The DMX address of the first strip to be patched.
LED address offset	ADVANCED The number of DMX channels between the start of two consecutive LEDs. Increase it to leave holes between your LEDs/fixtures, allowing merging ELM's output with another console. For example, you can control moving heads by letting ELM handles the colors and a console handles the movement.
Break universe after	ADVANCED Automatically start patching in the next universe when reaching this limit (number of strips of LEDs). Set to 0 to break only when the universe is full.

You've got the patching direction wrong? No problem. You can easily flip your strips horizontally and vertically later. For snake mode, right-click in the strip list and use the select odd/even option.

Want to control more complex DMX fixtures like moving heads? Let say your moving head has 20 channels and the RGB channels start at 3. In ELM, patch it with a start address of 3 and a LED address offset of 20. ELM will send 0 for the unused channels, which allows merging the DMX data from ELM with the DMX data from a console. The console should provide the values for the pan and tilt and the all other channels except the RGB.



Duplicate Strips Dialog

Shortcut key: alt-D

Copy the selected strips and create new strips by applying certain transformations.

Number of duplicates	The number of times you want to copy the selected strips.
Group and sub-group	Use these two groups to help you quickly find your strips later. When creating multiple duplicates, the primary group will automatically be appended with a counter.
Universe offset	The offset used to calculate the first DMX universe of the newly created strips.
Address offset	The offset used to calculate the first DMX address of the newly created strips.
X offset	The horizontal position offset applied to the newly created strips.
Y offset	The vertical position offset applied to the newly created strips.



Rotate offset	The rotation in degrees applied to the newly created strips.
Rotate center, offset X, offset Y	The position where the rotation will occur and how to offset the rotation center (for example, to leave a hole in the middle of the rotated strips).

When you're in the design phase of the lighting installation, keep in mind the duplicate options. They allow creating complex shapes by copying simple elements. This is a real time saver.

To make sure certain strips always stay together, use the bundle feature. You can create complex shapes by combining multiple simple elements. See the bundle/unbundle options in the Edit Zone.

To copy strips to another stage, select your strips and use the copy (ctrl-c) and paste (ctrl-v) keyboard shortcuts. You can also right-click in the Strip List to see all options.



Edit Strips Dialog

Shortcut key: alt-E

Edit the selected strips and allow changing the patch.

LEDs per strip	The number of LEDs per strip.
Type	The pixel type. See Add Strips Dialog (Quick Patching).
Intensity	Adjust the output intensity to equalize the luminosity and compensate for manufacturing and power differences.
Shape	Select a predefined shape to position your strips on the stage. For arrays, you want to use lines.
Group – primary, secondary	Use these two groups to help you quickly find your strips later.
DMX protocol	Select the output method for DMX. For example, Art-Net or sACN E1.31.
Start universe	The universe of the first strip to be patched.
Start address	The address of the first strip to be patched.
LED address offset	ADVANCED The number of DMX channels between the start of two consecutive LEDs. Increase it to leave holes



	between your LEDs/fixtures, allowing merging ELM's output with another console. For example, you can control moving heads by letting ELM handles the colors and a console handles the movement.
Break universe after	ADVANCED Automatically starts patching in the next universe when reaching this limit (number of strips or LEDs). Set to 0 to break only when the universe is full.
Apply changes to other stages	Executes your changes on the matching strips in other stages. It is handy when you have copied the same strips in multiple stages in order to keep them in sync.
Re-Patch (alt-P)	Forces redoing the patch to make sure all selected strips are patched one after another.

Offset/Resize Strips Dialog

Shortcut key: alt-O + enter

Precisely change the position and size of the selected strips.

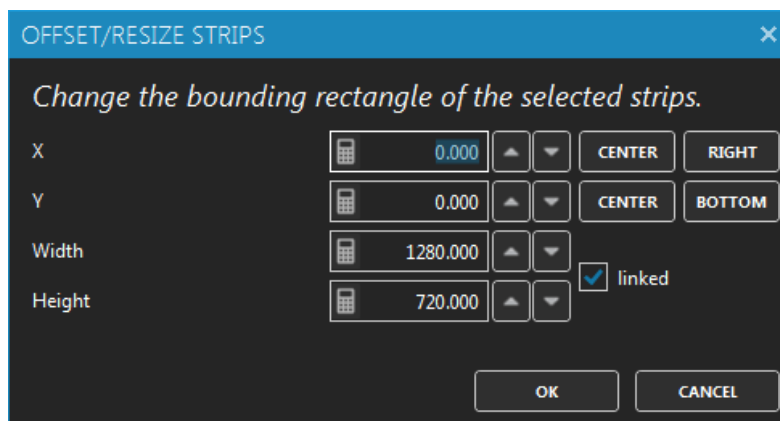

X	The position of the left boundary of the rectangle. A value of 0 means the far left of the stage.
Y	The position of the top boundary of the rectangle. A value of 0 means the top of the stage.
Width	The horizontal length.
Height	The vertical length.
Linked option	When checked, the initial aspect ratio is preserved when changing the width or height.

Right-click in a numeric box and move the mouse left/right to quickly change the value.



Stage Tab

Shortcut key: alt-g

Size	The mapping size of the stage. Change it with the resize button.
Output blur	Blurs the output in order to smooth away the rough edges. This can improve significantly the rendering of fast paced effects on low resolution LED displays. However, it can be pretty CPU intensive.
Preview opacity	Determines the visibility of the preview. You can disable the preview to save CPU by setting the opacity to 0.
Background image	To help you position the LED strips like in the real world, you can display an image on the background of the stage.
Offset and scale	Allows positioning the background image where you want.
Opacity	Determines the visibility level of the background image.
Sticky notes	Puts notes anywhere on the stage to remember key points of the mapping and TODOs.
Grid (ctrl-G)	Configure the snap to grid feature by specifying size of a cell in pixels. Use the offset X-Y to align the top-left cell with your design.
Monitor (alt-O)	Opens a monitor window to help you see the final result of the mapping.
LED snapshot	Exports a PNG image showing the exact position of every LED. This is useful for motion designers as they can use the snapshot as a content guide.

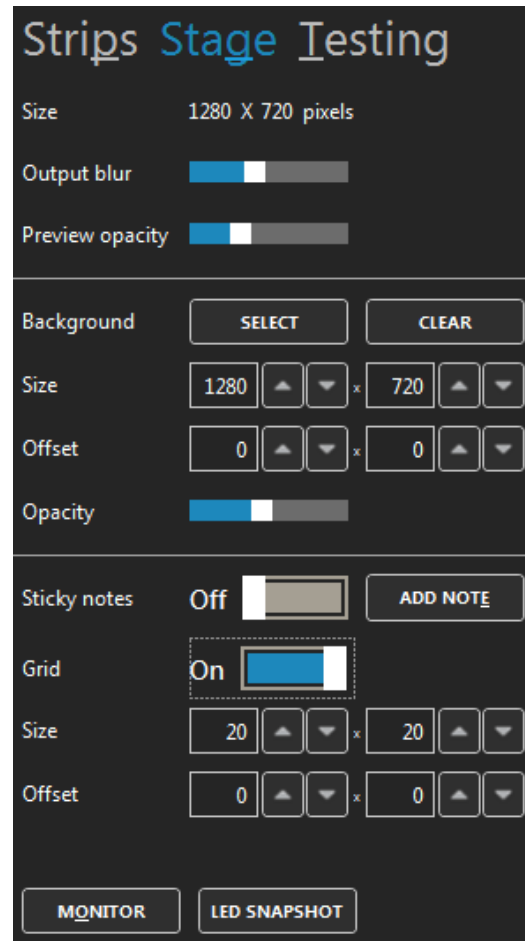



When you are editing and zoomed in very closely, if a media is playing in the preview, your computer may have a hard time. To help it, disable the preview by setting the preview opacity to 0%.

Here's the monitor window. You can see the result of the stage only or after all stages have been merged. When you don't have access to the real fixtures, this is an indispensable tool while creating effects. Alternatively, you can use any 3rd party visualizer able to receive the LED rendering via NDI (see NDI output in the Stages Manager) or supporting Art-Net or sACN.

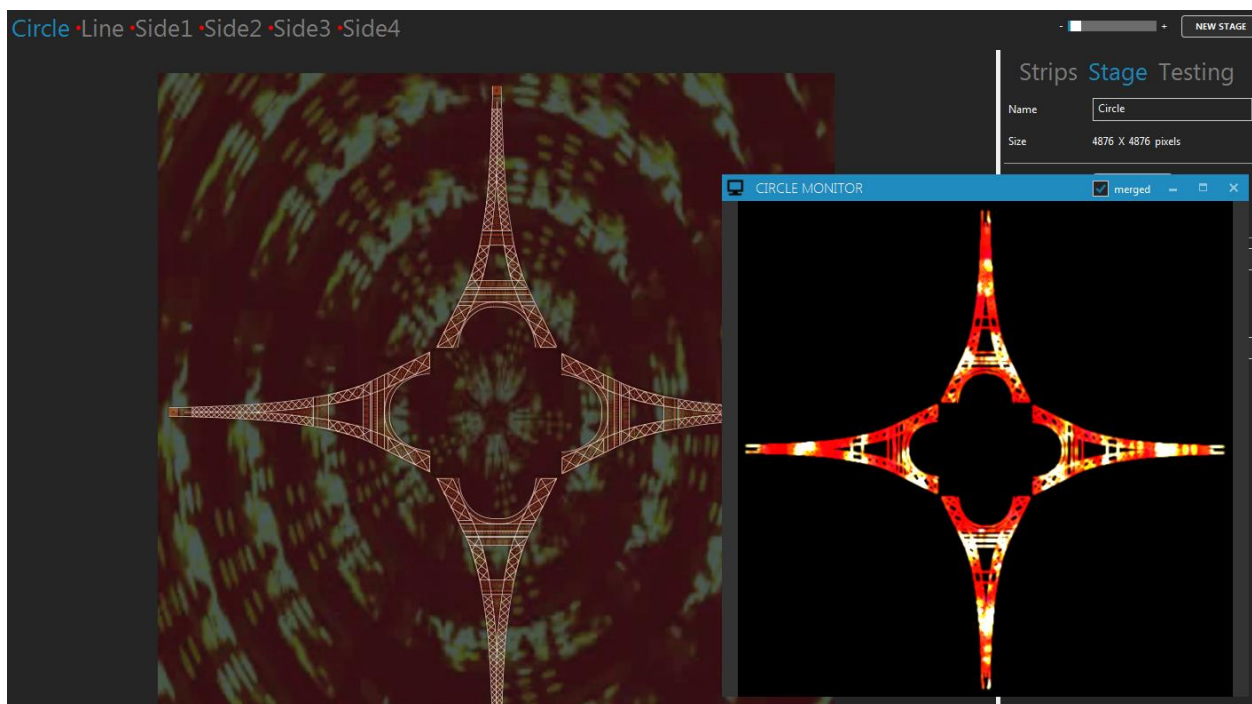

Try reducing the stage's size and see if the output is still good. Also reduce your videos and other media size accordingly to potentially save a lot of CPU. High resolution media is not always a good thing!



Testing Tab

Shortcut key: alt-T

Quickly test the mapping by generating a rectangle that you can move over the strips.

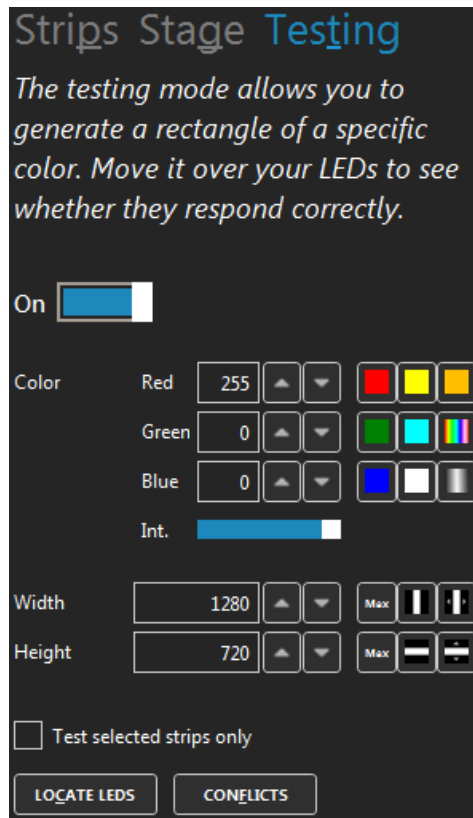

On/Off switch	Activates the testing mode.
Color	Changes the color of the testing rectangle. It is handy to test the color component order of your strips (RGB, BGR, etc.).
Width, Height	Changes the size of the testing rectangle.
Test selected strips only	If checked, only the selected strips in the Strips Tab will be under test. The other strips will all be off.
Locate LEDs	Locates each LED in the real world by going through a list. Alternatively, you can put the mouse over a LED in the editor. The LED number and its DMX address are displayed which is handy to count the LEDs and troubleshoot addresses.
Conflicts	Analyzes all patched LEDs of the current stage and looks for overlapping DMX addresses. In some situations you may want to have duplicated LEDs on the stage but if this isn't the case, you should adjust the DMX addresses.



Reduce the width and height of the testing rectangle and drag the rectangle around the stage. This way, you can see if the patch order is right. For example, if dragging the rectangle from left to right makes the LEDs go on from right to left, then you know you need to flip them horizontally. To do so, go in the Strips Tab and click the Flip X button.

Quickly test the red, green and blue component order of your LEDs by generating a pure red, pure green and pure blue test. For each test, note the color of your LEDs. If you're not getting a RGB order, edit your LED strips and select the LED type corresponding to the order you've observed (BGR, GRB, GBR...).

While the testing mode is active, the DMX is constantly being outputted at the full output rate, even when there's no change. This is handy while you're configuring your LED controllers and want to see if it's working. This is also a good way to test whether your network supports the load.

Use the "test selected strips only" option, go in the Strips Tab and change the selection in the strip list. This is similar to traditional lighting consoles locate function.



Stages Manager

Shortcut key: alt-N

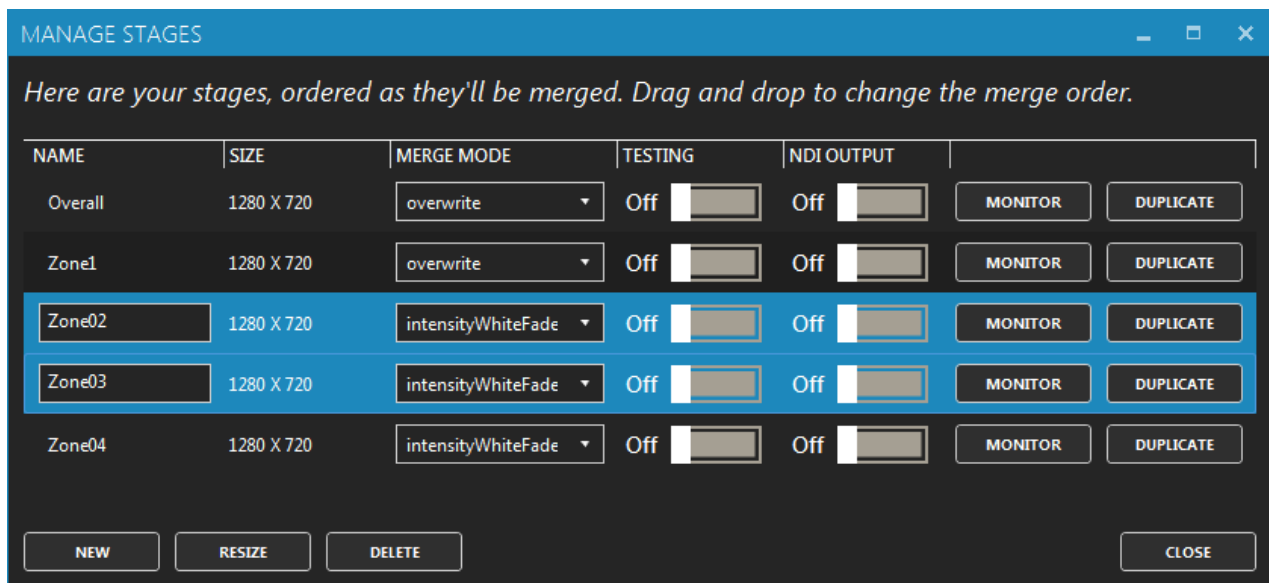

Select multiple stages in the list to modify them all at once. The first stage of the list is the bottom media layer and the following stages can override any preceding stages. Drag and drop stages to reorder.

Name	The name of the stage. Select a stage to edit its name.
Size	The size in pixels of a stage.
Merge mode	Specifies how the values are merged when multiple stages target the same LEDs. The merge starts with the stage at the top of the list. You can reorder the stages with drag and drop. See Stage Merging and Layering for more details.
Testing	Activates the testing mode.
NDI output	Stream the LED rendering via NDI to be used by 3D visualizers like WYSIWYG, Capture or Realizzer. This way you don't need to patch your LEDs in the visualizer and you get a very high quality and live LED rendering.
Monitor	Opens a monitor window to help you see the final result of the mapping for this stage.
Duplicate	Copies the stage to get a new media layer.
New	Creates a new stage.
Resize	Resizes all selected stages.
Delete	Deletes all selected stages.



Media Library

Shortcut key: alt-M

You can manage your media and see what's active. Up to 255 media items can be loaded.

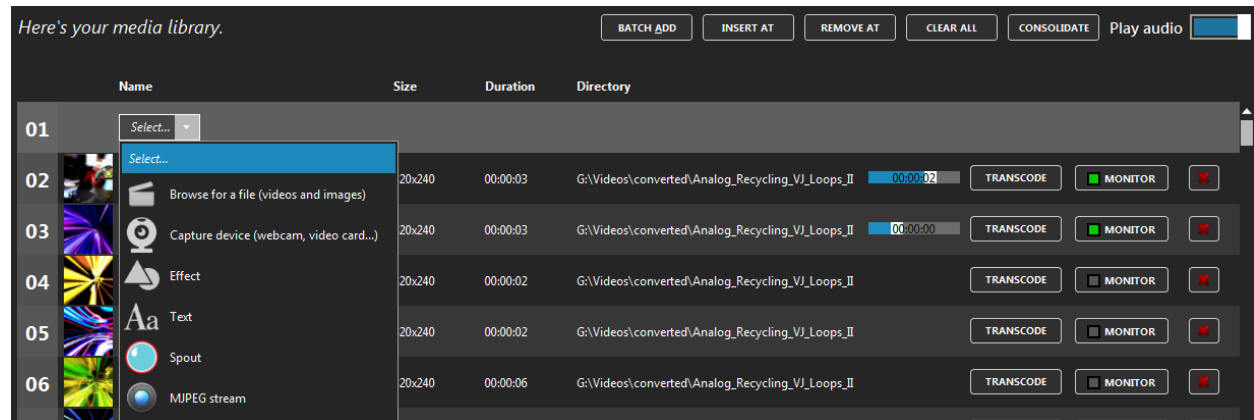

Batch add (alt-A)	Loads multiple video and picture files at once.
Insert At, Remove At	Inserts or removes a slot and offsets other media accordingly.
Clear all	Resets the library.
Consolidate	Copies all files in the same directory to make it easy to move your project file to another computer.
Play audio	For videos, plays the audio track if available.
Transcode	For videos, converts to a MPEG4 format that should play on all computers. Also adjust contrast and brightness.
Playback position indicator	For videos, shows the position and allows seeking, which is handy for long videos to test specific parts.
Monitor	Opens a window showing the images coming from a media source.
Delete button	Clears a media slot and allows selecting another media.
Swap items and reorder	You can swap items by using drag and drop.

Video Files (with or without audio)

Most video formats are supported when the appropriate DirectShow video codecs are installed. By default, ELM can play these files: .mov, .avi, .wmv, .mpeg, .mp4, .mp2, .mkv, .webm, .ogv and .ogg. There's no video size and resolution limits. The audio track is played back on the default sound device. If not needed, you can remove the audio by using the transcode button.

The recommended video format is MPEG4 in an avi file. For smaller files at the expense of a higher CPU usage, you can use H264 in an avi file.



Picture Files

Use images like bmp, jpeg, gif (animated or not) and png.

Capture Devices

Use live videos captured with a video card input or a connected camera like a webcam. Any DirectX/DirectShow compatible hardware and software are supported.

Effects

The built-in effects give you pixel-perfect and configurable visuals.

Texts

Generate scrolling text with various fonts.

Spout (v. 2.006)

Use live videos generated by the most common video frameworks and VJ software. This includes Resolume, Ableton Live, Processing, Max/Msp, TouchDesigner, Cinder, OpenFramework, VVVV, Isadora, After Effects, Mapio, Unity3D and more. The Spout integration gives you total control over the content and is the way to go when you want interactive visuals.



Network Device Interface (NDI v. 3.8)

Receive live video streams via the network, as commonly used in professional live show productions. Easily connect ELM to a multitude of NDI compatible hardware and software, including capture cards, IP cameras and video over the cloud. NDI has been developed by NewTek - <http://NDI.NewTek.com>.



MJPEG Streams

It's the most basic way to receive video streams via the network. If your IP camera doesn't support the more complete NDI protocol, it should at least support MJPEG streaming.

To quickly test your installation without having the final videos, just use the built-in effects. You can create your schedules and test everything right away. Then when you'll get your videos, replace the built-in effects.

Media file paths are saved relatively to your project file. Use the consolidate feature to copy all files in a directory next to your project. Then copy everything to your other computer.



Schedules

Shortcut key: alt-H

Each stage has its own schedule. A schedule can contain as many playlists as you need and you trigger them with an activation time, date range and day of week.

The screenshot shows the 'Stage01' configuration window. It features a table of playlists and a detailed view of a selected playlist. The playlist table has columns: STATUS, PLAYLIST, ACTIVE, START TIME, and DURATION. The detailed view has columns: STATUS, MEDIA, DURATION, MAX PLAY COUNT, MAX PLAY TIME(S), and COLOR. Below the table are controls for 'ADD MEDIA', 'DELETE', 'Start time' (0:00 relative to Midnight), 'Duration' (Auto and Loop), 'Start/end dates' (jan 1 to dec 31), 'Active days' (Su, Mo, Tu, We, Th, Fr, Sa), and 'Transitions' (crossfade, 2.0 s, Intensity level, Speed 1.0 x).

Add playlist (alt-P)	Creates a playlist for the current stage.
Rename playlist	Right-click on a playlist to see the menu or double-click on its name.
Copy/Paste playlist	Right-click on a playlist to see the menu.
Stop during daylight	Stops this stage's schedule during daylight hours. Based on the sunrise and sunset times.
Scheduler On/Off	Temporarily stops all schedules. It is handy to take over and manually select what's playing on each stage in the live mode. This option isn't saved to the project file.
Sunrise, Sunset times	Computed based on your location. See Time.

Select a playlist to see its settings. Double click to play. The playlist settings are:

Add media (alt-A)	Adds one or multiple media to the playlist.
Delete	Removes the selected items from the playlist.
Start time	The time of the day to start the playlist.
Relative to	Determines how to interpret the start time.



Duration	The duration of the playlist (end time).
Loop	Repeats the playlist indefinitely (loop).
Start and end dates	The date range (inclusive) when the playlist is active.
Active days	The days of the week when the playlist is active.
Transitions	The type and duration of transition effects, from the classic crossfade to complex effects rotating and scaling the media. If color filters are used, a nice transition will also occur between the colors.
Intensity level	The luminosity level (dimmer). Set to 0 to deactivate the stage.
Speed	The playback speed. Does nothing for live video streams.

Drag and drop media items in the list to reorder. Select one or multiple items and right-click to see the menu, allowing copying and pasting items across playlists. The settings for each media item are:

Status	The playing status, indicating the playing time and number of repetitions done.
Media	The associated media. Click to change it.
Duration	For some types of media like video, displays the total play time.
Max play count	The maximum number of times to play this media before playing the next one.
Max play time	The maximum number of seconds to play this media before playing the next one.
Color filter	The RGB color filter to apply to the media. White means no filter.

If “infinite time” is displayed for the status of an item that means this item will play indefinitely or until the playlist ends (if the playlist duration is specified). Specify a max play time if this isn't what you want.

Turn off the scheduler to temporarily take control of what's playing on your stage using the live mode.

Select multiple media items to change them all at once when modifying the play count, play time and color filter.



Live Mode

Shortcut key: alt-L

The main goal of the live mode is to let you see what's playing on each stage and monitor the status. For example, if a playlist is running, you'll see what's happening in real-time, including the transitions. If nothing is controlling the stage, you'll be able to manually select what's playing.

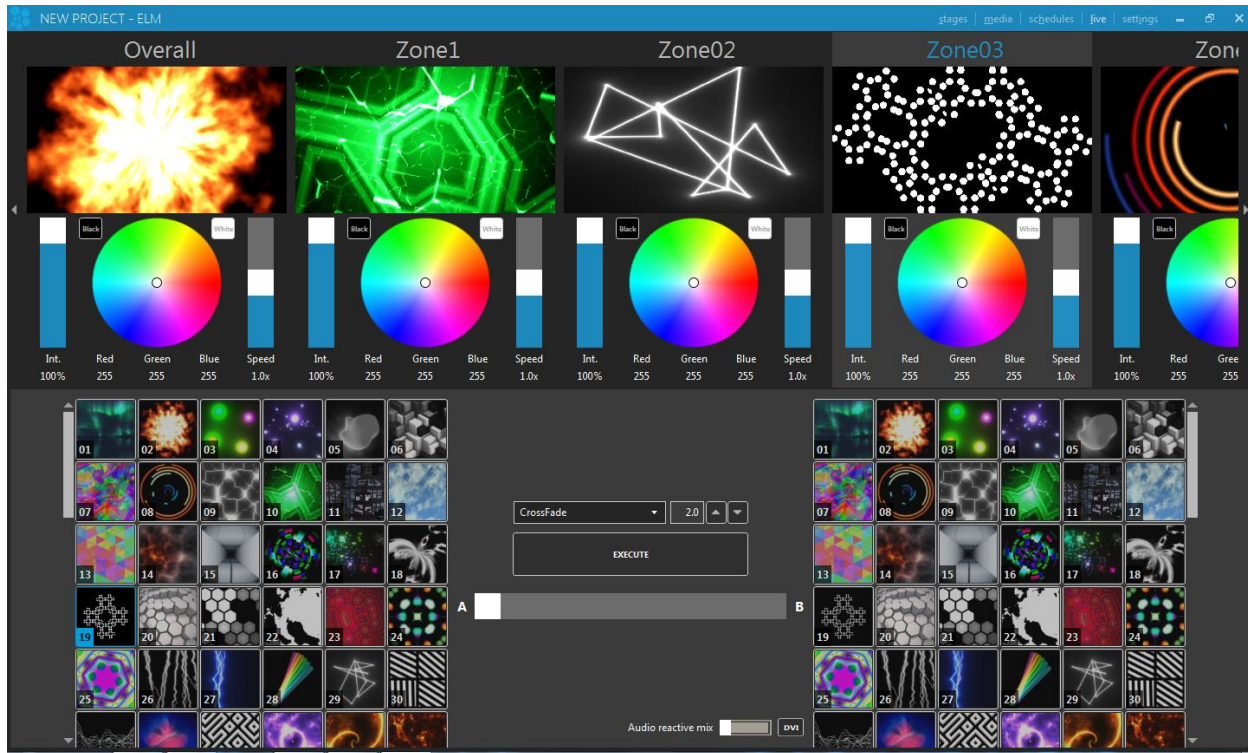

A and B sides	Shows the loaded media. Click a media to select it. Right-click to configure it.
A-B Fader	Smoothly changes the current media between the A and B sides, using the selected transition effect.
Execute	Automatically creates a transition from A to B or B to A depending on the most active side.
Transition effect and duration	Selects one of the 40+ transition effects and its duration in seconds.
Intensity	The luminosity level (dimmer). Set to 0 to deactivate the stage.
Color wheel	Filters the color output. It works like a color gel, where if you select the red color, only red pixels will be visible at the output.
Speed	The playback speed. Used for certain media types only,



	including video files, built-in effects and texts. Does nothing for live video streams.
DVI	Opens a window to output the video to a projector or TV. Double-click on the window to maximize. The position of the window is saved in the project file.
Audio reactive mix	Automatically mixes your media in sync with the music. It's a kind of auto-pilot, which is handy to create a show very quickly. Click the "... " button to select the audio input.

You can use ELM to output video to a projector or TV without controlling LEDs. Simply create a stage and don't put any LEDs on it. Then in the live mode, click the DVI button.

Using black and white media allows you to use the color filter and get exactly the RGB color you want as output.

Use the live mode as a monitor to help you see what's going on while remotely controlling ELM with another lighting console. You can also open multiple DVI outputs (one per stage) and use them as monitors.



Settings

Shortcut key: alt-I

Project

This is the overall panel, displaying the most important info about your project status.

New project	Closes the current project and start a new one.
Load (ctrl-o)	Opens an existing project.
Save as	Saves the project under a new name.
Save (ctrl-s)	Saves the project.
Export patch	Creates an html file containing all strips/fixtures to be opened in a web browser or Excel.
DMX universes	The number of DMX universes used by your project. This is the number used to calculate your license limit (if any).
Stages	The number of stages in your project.
Strips	The number of strips in all stages.
Mapped LEDs	The number of LEDs inside the mapping zones in all stages (including duplicated LEDs).
Output rate (fps)	The number of times per second DMX packets are sent. Default is 30, max 120.
DMX output	Activates or temporarily disables the DMX output. This is handy during testing.
Lock stages	Prevents accidentally editing the stages by requesting a password to unlock (last 4 characters of the hardware ID).
Run at startup	Automatically runs ELM when Windows starts and loads the last opened project file.

A project backup file is created every 5 minutes. To avoid slowdown during a live show, you need to manually save the project to trigger the backup creation. To open a backup, select the Backup file type in the file browser when opening a project. To set the backup to be the current project, simply save the project.

Art-Net

Settings for the Art-Net universes.

Adapter	Selects a network adapter for the output.
Universe display	By default, universes are in the hexadecimal format, where the first digit is the Net (0 or 1) followed by the Sub-Net (0-F) and then the universe (0-F). In decimal mode, the universes are displayed from 0 to 511.



Scan nodes	Opens a window and shows the detected Art-Net nodes. Click the configure unicast button to activate Art-Net unicast and send the universes to the subscribed nodes.
Optimize frames	When activated, universes are sent only when there's a change and only the channels that have changed are sent, which may considerably reduce the network load. Older or low-powered nodes may not support it.
ArtSync	When activated, sends a ArtSync packet after all universes have been sent. This makes sure all outputs to the lights are in sync and prevents tearing problems.
Universe IP addresses	For each universe, enter an IP address to enable unicast and send the DMX packet to a specific node. Type broadcast to send the universe to all connected nodes in the network. Unicast is preferred when using more than 64 Art-Net universes or a WiFi network.

sACN

Settings for the sACN universes.

Adapter	Selects a network adapter for the output and the input if using remote control with sACN.
First universe	Since sACN supports thousands of universes, set the first universe to use.
Priority	Selects the priority level used for merging multiple sACN data sources. This is useful when using two ELM computers and you want to use one as a backup by setting its priority to a lower level than the main computer.
Optimize frames	When activated, universes are sent only when there's a change, which may considerably reduce the network load.
sACN Sync	When activated, sends a sync packet after all universes have been sent. This makes sure all outputs to the lights are in sync and prevents tearing problems. The sACN controllers need to support sACN sync.
Universe IP addresses	For each universe, enter an IP address to enable unicast and send the DMX packet to a specific node. Type multicast to send the universe to all subscribed nodes in the network. Unicast is preferred when using more than 64 sACN universes with a network switch not IGMP v2 ready or a WiFi network.



KiNet

Settings for the Philips Color Kinetics devices (power supplies). The protocol version is KiNet v2 (PORTOUT). You map each KiNet device's port to a universe in ELM. You can map up to 2048 ports. Use Philips QuickPlay Pro to configure and get the IP addresses of your KiNet devices.

Adapter	Selects a network adapter for the output.
Device IP addresses	Enter the IP address of your device.
Port	Enter the destination port for each device (1-16).

Audio

Activate and configure up to 8 audio inputs. The audio inputs are used by the audio reactive effects and the audio reactive mix. Activate the loopback input to listen to what's playing on this computer.

Activation switch	Determines whether this audio input is activated. Deactivate unused inputs to save resources.
Volume	Adjusts the input volume.
Lower/higher frequencies (Hz)	Adjusts the frequency range to be used for the audio analysis.
Up/down arrows	Moves the audio input to another slot. This way if the position of an audio source changes, you'll not need to update all your audio reactive effects.
WaveIn/ASIO	Switch between the standard Windows Audio and the low latency ASIO modes.

Time

Settings for accurate sunrise and sunset times, automatically updated throughout the year based on your location.

Your position	Your latitude and longitude position on Earth. You can also select a preset in the list.
Offsets (minutes)	Offsets the sunrise and sunset times. For example, if you want to start the installation 2 hours before sunset, you enter (-120) in the sunset box.
Test helpers	Temporarily modifies the current time and date to help you test your schedule. These values aren't saved in the project file.



License

Manage your licenses. You can import multiple licenses to get more DMX universes.

Backup	Saves your license file in case you need to reinstall your OS.
Import	Imports a license file.
Hardware ID	Your unique computer's ID, used to generate the licenses.

Remote Control

ELM can be remotely controlled in many ways. Multiple inputs can be active at the same time to give you even more flexibility. The DMX input always takes priority.

DMX – Art-Net, sAcn and Enttec USB Pro

Settings for remotely controlling ELM with a lighting console.

Input mode	Selects how you want to remote control ELM. The current options are Art-Net, sACN and a Enttec USB Pro interface.
Network adapter	For Art-Net only, you can select a different network adapter for output and input.
Universe	Selects the DMX input universe.
Address	Selects the DMX address for the first stage.
Fixture mode	Selects the level of control you want (Basic or Extended).
DMX value mode	Percent: makes it easy for consoles working in percent. Raw: makes it easy for consoles working in the 0-255 DMX range.

The DMX sheet showing what can be controlled and by which channel is integrated in ELM. It is dynamically generated based on the current remote settings and your stages. This way, you can't lose it!

When no DMX data is received for more than 5 seconds, the remote control mode will automatically be deactivated. This is a failsafe feature in case the remote console has a problem. When this happens, the schedule resumes right away. If there are no schedules, then the current media will continue to play.



Basic Fixture Mode (8 channels per stage)

Channel	Name	Values	Note
1	Remote control mode	0: Remote control deactivated 1-254: Reserved, don't use 255: Remote control activated	Remote control activated only when receiving 255. 0 disables the remote control mode and the stage goes back to being controlled via the schedule (if any) or manually.
2	Media index	0: No function 1-99: Media index	The media to play. If needed, a transition (crossfade) is automatically executed between the current media and the new one. This effectively controls the A and B sides in the live panel for you.
3	Intensity level	0: Stage deactivated 1-255: Level	The output level (dimmer). When at 0%, the stage is considered to be deactivated and doesn't override stages with a lower precedence anymore - it becomes transparent. To keep the stage activated and force a black output, use the color filters at 0%.
4	Red filter	0-255	Filters the color output.
5	Green filter	0-255	Filters the color output.
6	Blue filter	0-255	Filters the color output.
7	Playback speed	0: Paused 1-255: Speed up to 10x. 25 = 1x	For some type of media like videos, effects and texts, the speed controls how fast the playback goes. For live streams, the speed has no effect.
8	Transition duration	0: No transition 1-255: Duration up to 20 seconds. 12 = 1s.	When transitioning between media, this controls the duration of the crossfade.



Extended Fixture Mode (15 channels per stage)

Channel	Name	Values	Note
1	Remote control mode	0: Remote control deactivated 1-254: Reserved, don't use 255: Remote control activated	Remote control activated only when receiving 255. 0 disables the remote control mode and the stage goes back to being controlled via the schedule (if any) or manually.
2	Intensity level (MSB/coarse)	0: Stage deactivated 1-65535: Level	The output level (dimmer). When at 0%, the stage is considered to be deactivated and doesn't override stages with a lower precedence anymore - it becomes transparent. To keep the stage activated and force a black output, use the color filters at 0%.
3	Intensity level (LSB/fine)		
4	Red filter	0-255	Filters the color output.
5	Green filter	0-255	Filters the color output.
6	Blue filter	0-255	Filters the color output.
7	Media A speed	0: Paused 1-255: Speed up to 10x. 25 = 1x	For some type of media like videos, effects and texts, the speed controls how fast the playback goes. For live streams, the speed has no effect.
8	Media B speed	0: Paused 1-255: Speed up to 10x. 25 = 1x	For some type of media like videos, effects and texts, the speed controls how fast the playback goes. For live streams, the speed has no effect.
9	Media A index	0: Empty 1-99: Media index	The media to play on side A.
10	Media B index	0: Empty 1-99: Media index	The media to play on side B.
11	Media mixing position (MSB/coarse)	0-65535 0: media A fully active 65535: media B fully active	Controls the position of the mixing effect, from A to B.
12	Media mixing position (LSB/fine)		



13	Mixing position modifier	0: No function 1-255: Various mapping functions	Spices up the mixing position by applying a function like bounce, sigmoid and exponential. See the list of functions in ELM.
14	Mixing effect	0: no effect 1: crossfade 2: black fade 3: white fade 4-255: Various effects	Determines the effect to be applied when mixing the A and B sides. From simple crossfade to complex effects including rotations, scaling and translations. See the list of effects in ELM. When not needed, select the 'no effect' to avoid wasting CPU.
15	Reserved (unused)		



OSC

Settings for remotely controlling ELM via OSC (Open Sound Control) over the network. ELM listens for incoming OSC on all network adapters.

```

/elm/stages/{stage name}/
  live/
    intensity          0..1
    rgb                0..1, 0..1, 0..1
    media              0..99
    speed              0..10
    transitionFx       0..43
    transitionDuration 0..9999 seconds
    audioMixControlled {0: no, 1: yes}
    remotelyControlled {0: no, 1: yes}
  mix/
    position          0..1
  A/
    media            0..99
    speed            0..10
  B/
    media            0..99
    speed            0..10

scheduler/
  running            {0: no, 1: yes}
  playlists/{playlist name}
    running          {0: no, 1: yes}

```

Addresses and names are case-insensitive.

Media index 0 is an empty slot.

RGB can be sent in 3 parts at the /r /g and /b addresses.

audioMixControlled: controls the audio mix activation.

remotelyControlled: determines whether OSC overrides the scheduler.

Use * (wildcard character) in the stage name to target multiple stages at once. For example, /elm/stages/*/XYZ targets all stages.

/elm/stages/background*/XYZ targets all stages with a name starting with background.



HTTP

Settings for remotely controlling ELM via HTTP, which is a protocol based on TCP/IP. This is the most reliable way to integrate ELM with control systems like Crestron and Pharos or to create custom web interfaces. ELM listens for incoming HTTP requests on all network adapters.

Request	Parameters	Output
GET /elm/stages		list of stage names
GET /elm/stages/{stage name}/live		state of the requested stage
POST /elm/stages/{stage name}/live	intensity 0..1 media 0..99 speed 0..10 transitionFx {name}, transitionDuration 0..9999 red 0..255 green 0..255 blue 0..255 audioMixControlled 0 or 1 remotelyControlled 0 or 1	
GET /elm/stages/{stage name}/scheduler		state of a scheduler
POST /elm/stages/{stage name}/scheduler	running 0 (no) or 1 (yes) RGBRemotelyControlled 0 or 1 intensityRemotelyControlled 0 or 1	starts/stops the scheduler overrides the scheduler's RGB overrides the scheduler's intensity
GET /elm/stages/{stage name}/scheduler/playlists		list of playlist names
GET /elm/stages/{stage name}/scheduler/playlists/{playlist name}		state of a playlist
POST /elm/stages/{stage name}/scheduler/playlists/{playlist name}	running 0 (no) or 1 (yes)	starts/stops the playlist
GET /elm/media/slots		list of filled media slot ids
GET /elm/media/slots/{id}		state of a media slot
GET /elm/media/slots/{id}/thumbnail		PNG image
POST /elm/media/slots/{id}	path (load a new file)	state of the updated media slot

Addresses and names are case-insensitive. Parameters can be provided in the query string or form data. Media id 0 is an empty slot.

For example, to start the playlist "NIGHT" of the stage "FRONT", the request is:

```
POST /elm/stages/FRONT/scheduler/playlists/NIGHT?running=1
```

Use * (wildcard character) in the stage name to target multiple stages at once.

The base URL to access the API is: **http://YOUR-COMPUTER-NAME:port/elm**. If you prefer, you can replace the computer name by its IP address.

You can restrict the access to the API by activating the Basic Auth feature. For more details see https://en.wikipedia.org/wiki/Basic_access_authentication.



Troubleshooting

Output - Art-Net/sACN/KiNet

Problem	Possible causes	Solutions
No Art-Net nodes detected in the scan nodes dialog.	<p>The node IP address may be incorrectly configured. For example, the computer's IP is 192.168.1.X and the node's IP is 192.168.0.Y.</p> <p>The wrong network adapter may be selected in ELM.</p>	<p>Change the IP address of your computer or your node to be on the same network, that is most of the time, the 3 first numbers need to be the same. The subnet masks also need to be the same. Usually, you want to use 255.255.255.0 as the subnet mask.</p> <p>Open the Start Menu, right-click on Network, and select Properties. The Network and Sharing Center opens...click on Manage network connections. Right-click on the network adapter you want to assign an IP address and click Properties. Highlight Internet Protocol Version 4 (TCP/IPv4) then click the Properties button</p>
Output lag (working but with intermittent delays).	<p>The network is overloaded, most of the time due to the use of broadcasting. By default with Art-Net, all universes are broadcasted (sent to all connected devices on the network). Some routers and switches may have problems under heavy load.</p>	<p>Enter your node IP addresses in the universe boxes to enable unicast sending. For Art-Net, click the scan nodes button and then the configure unicast button (see Art-Net). This greatly reduces the work your router/switch has to do.</p> <p>Alternatively, you can lower the ELM's output rate (see Project).</p> <p>Another way to reduce the network load is to enable the optimize frames option (see Art-Net).</p>
Some lights wrongly stay on for half a second or so.	<p>The most common cause is an unreliable network like a WIFI causing data packets to be discarded.</p>	<p>Disable the optimize frames option for Art-Net or sACN. ELM will continuously send data even when there's no change. You may need to reduce the output rate to avoid network overload.</p>



<p>The lights do nothing.</p>	<p>The nodes may not be properly configured or not plugged.</p> <p>The strips may be configured to use the wrong universes and/or addresses.</p> <p>No media is playing and ELM doesn't need to output anything.</p>	<p>Test the nodes with the configuration utility from the manufacturer. Check the IP address configuration as described above.</p> <p>Check the universes and addresses of your strips. You can use an Art-Net sniffer like the Artnetominator or Wireshark to see what ELM is sending.</p>
<p>The lights flicker.</p>	<p>The most common cause of flickers when using LED strips is that the wrong LED type or protocol has been configured in the LED controller. For example, selecting TM1803 instead of WS2811.</p> <p>Maybe some LEDs don't have enough power. It can cause flickers at the end of the strips.</p> <p>This may also be caused by using video content with little noise in it due to compression (may not be problematic when displayed on a screen but it becomes apparent on LEDs).</p> <p>Some older LED fixtures may not work well when using the Art-Net optimize frames option.</p>	<p>Start your LED controller configuration utility and check the configured LED type. Try different types if you're unsure.</p> <p>Enable the testing mode (see Testing Tab) and select a low brightness color. This will cause the LEDs to use less power. If the flickers go away, then the problem is due to not having enough power going to the LEDs. You'll need to inject more power.</p> <p>The testing mode generates a pure color, so if this isn't a power problem and a full white test color doesn't cause flickers, that means the video content is probably the problem.</p> <p>Disable the optimize frames option (see Art-Net).</p>



General

Problem	Possible causes	Solutions
ELM isn't starting and saying a dll is missing.	Probably the Visual Studio 2015 run-time component is missing.	Download and install the Visual C++ Redistributable for Visual Studio 2015 https://www.microsoft.com/en-ca/download/details.aspx?id=48145
Very high CPU usage.	<p>The computer can't handle your videos.</p> <p>You are looking at a stage and the computer is having a hard time drawing pretty graphics.</p> <p>The output rate is too high.</p>	<p>Reduce the resolution of your videos by using the transcode button (see Video Files). Transcoding can convert to an easier to decode format which may also save CPU.</p> <p>If you're using live video capture, try reducing the capture resolution.</p> <p>If the computer is already overloaded, try not to unnecessarily leave ELM on a graphic heavy screen. Minimize the ELM window or go in the setting/project tab. Also make sure to close all monitor windows.</p> <p>Alternatively, you can lower the ELM's output rate (see Project).</p>
When moving my project to another computer, the media are missing.	The ELM project file doesn't contain the media and the stage's background images.	You need to move the media to the other computer and put them at the same place relatively to the project file. A good practice is to create a media folder next to your project file. Alternatively, use the consolidate feature of the media library (see Media Library).
I see a blank screen when using a remote desktop app like LogMeIn or VNC.	The ELM user interface uses hardware acceleration (DirectX and OpenGL). Some remote desktop app doesn't support it or need special configuration.	You may need to configure your remote desktop app to support hardware acceleration. Alternatively, TeamViewer works well with ELM.
The eye candy effects aren't working on my Mac running Windows under Parallels.	ELM needs OpenGL 3.3 and Parallels only supports OpenGL 3.2.	Use Bootcamp instead of Parallels.



EULA

This End-User License Agreement (EULA) is a legal agreement between you (either an individual or a single entity) and the mentioned author and copyright holder (Lightjams inc.) and distributor (Enttec LLC) of this Software for the software product identified above, which includes computer software and may include associated media, printed materials, and “online” or electronic documentation (“SOFTWARE PRODUCT”).

By installing, copying, or otherwise using the SOFTWARE PRODUCT, you agree to be bounded by the terms of this EULA.

If you do not agree to the terms of this EULA, do not install or use the SOFTWARE PRODUCT.

SOFTWARE PRODUCT LICENSE

1. GRANT OF LICENSE. This EULA grants you the following rights: Installation and Use. Each license is registered to one person and covers the use of the SOFTWARE PRODUCT on one or multiple computers depending on the license type, so long as multiple computers are not used at the same time. The license is locked to the computer’s CPU and motherboard.

2. DESCRIPTION OF OTHER RIGHTS AND LIMITATIONS.

Limitations exist on Reverse Engineering, Decompilation, Disassembly and changing (adding, deleting or modifying) the resources in the compiled assembly of the SOFTWARE PRODUCT. You may not reverse engineer, decompile, or disassemble the SOFTWARE PRODUCT, except and only to the extent that such activity is expressly permitted by applicable law notwithstanding this limitation.

Updates and Maintenance

ELM updates are FREE of charge.

Separation of Components.

The SOFTWARE PRODUCT is licensed as a single product. Its component parts may not be separated for use on more than one computer.

Software Transfer.

You may not rent, lease or sublicense the SOFTWARE PRODUCT on a temporary or permanent basis.



Termination.

Without prejudice to any other rights, the Author of this Software may terminate this EULA if you fail to comply with the terms and conditions of this EULA. In such event, you must destroy all copies of the SOFTWARE PRODUCT and all of its component parts.

3. COPYRIGHT.

All title and copyrights in and to the SOFTWARE PRODUCT (including but not limited to any images, photographs, clipart, libraries, and examples incorporated into the SOFTWARE PRODUCT), the accompanying printed materials, and any copies of the SOFTWARE PRODUCT are owned by the Author of this Software (Lightjams inc). The SOFTWARE PRODUCT is protected by copyright laws and international treaty provisions. Therefore, you must treat the SOFTWARE PRODUCT like any other copyrighted material.

LIMITED WARRANTY

NO WARRANTIES.

The Author of this Software expressly disclaims any warranty for the SOFTWARE PRODUCT. The SOFTWARE PRODUCT and any related documentation is provided "as is" without warranty of any kind, either express or implied, including, without limitation, the implied warranties of merchantability, fitness for a particular purpose, or noninfringement. The entire risk arising out of use or performance of the SOFTWARE PRODUCT remains with you.

NO LIABILITY FOR DAMAGES.

In no event shall the author of this Software be liable for any special, consequential, incidental or indirect damages whatsoever (including, without limitation, damages for loss of business profits, business interruption, loss of business information, or any other pecuniary loss) arising out of the use of or inability to use this product, even if the Author of this Software is aware of the possibility of such damages and known defects.