

Pixel Octo

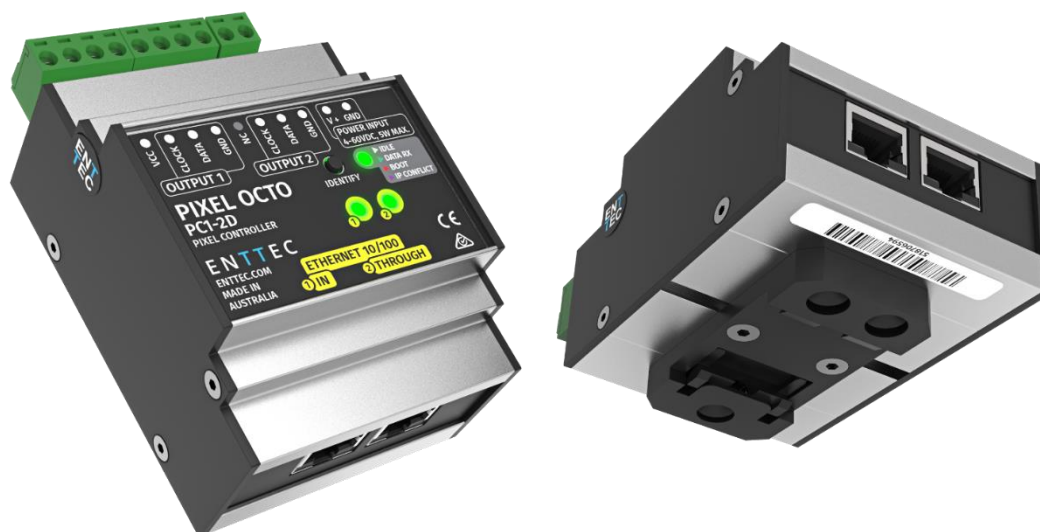

Features

- Web configurable
- Firmware updateable
- Supports the following DMX over Ethernet protocols:
 - Art-Net
 - Streaming ACN (sACN)
 - ESP
 - KiNET
- Configurable Static or Dynamic (DHCP) IP (DHCP by default).
- Netmask and gateway updateable
- Up to 8 ethernet universes support (maximum of 4 universes per output port)
- Configurable pixel colour ordering.
- Monitors device temperature
- Monitors and displays the network traffic
- Easily extendable network - daisy chain ethernet connection up to a maximum of 50 devices
- Compatible with CLK LED Tapes
- White Pixel Order compatibility
- 35 mm DIN mountable
- Flexible wiring configurations
- Executes live effects on the fly
- Save dynamic effects created as a presets for quick access.
- User-friendly interface to create and execute live effects on the fly
- Aluminium Enclosure
- Top view indicator lights and button
- Pluggable terminal blocks
- Dual Spring 35mm DIN rail brackets

Wiring Diagrams

LEGEND

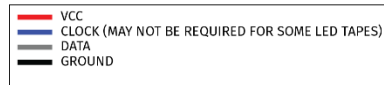

POWER CONNECTION (POWER INPUT TERMINALS)

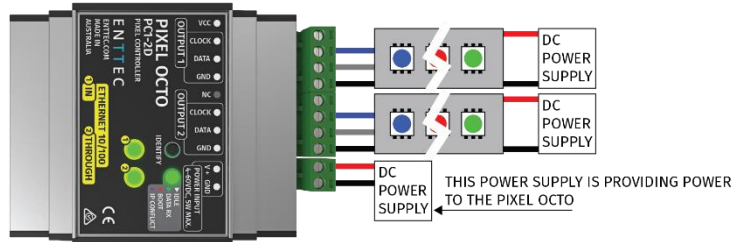

POWER CONNECTION (VCC TERMINAL)

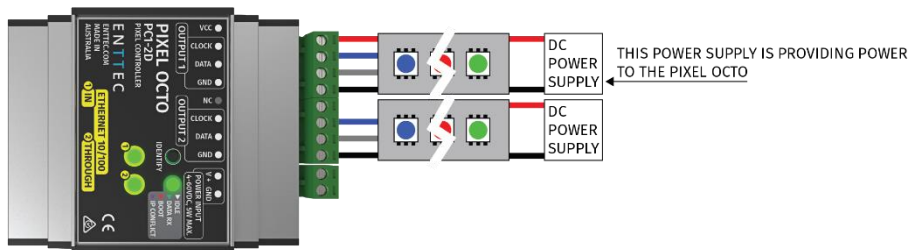

POWER CONNECTION (USING TERMINAL SPLITTERS)

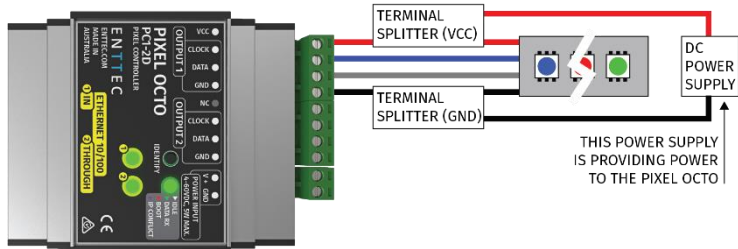

MULTIPLE LED POWER INJECTION

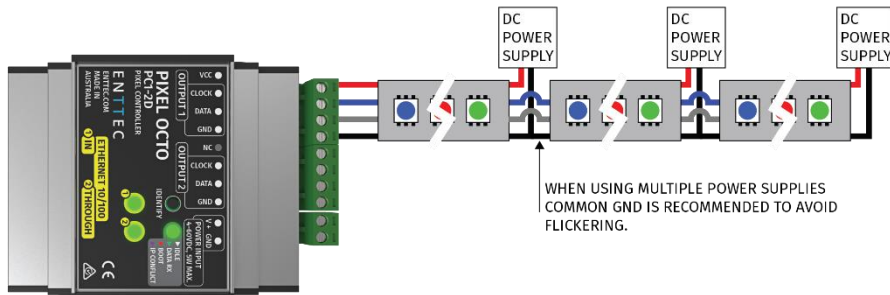

MULTIPLE LED TAPE SECTIONS

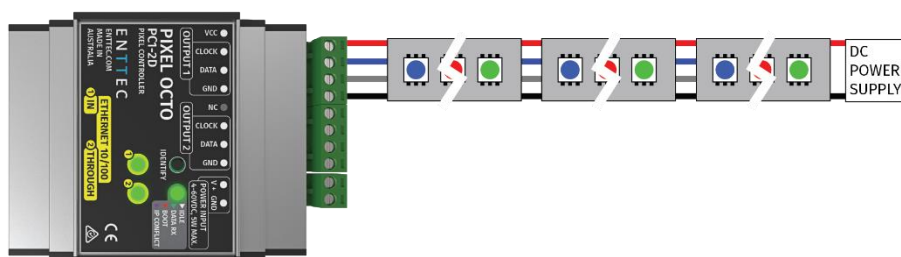

Safety

- This unit is intended for indoor use only.
- Do not expose this device to rain or moisture, doing this will void the warranty.
- Make all connections before powering on
- Do not remove the cover, there are no user serviceable components inside.
- Never plug this unit into a dimmer pack
- Ensure input voltage is within the specified limits
- Ensure this device functions within the [recommended operating temperature](#)

Physical Dimensions

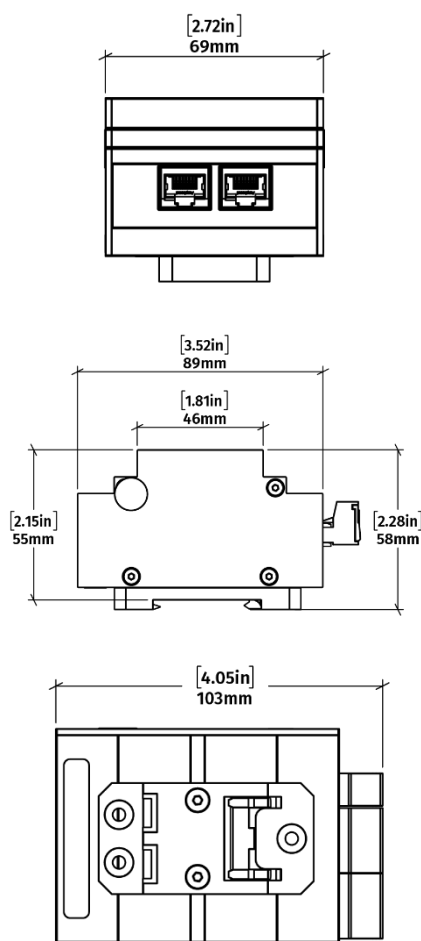

Ordering Information

Part Number	Description
71520	Pixel Octo

Specifications

Item	Specification	
Input Voltage	4-60V DC	
Maximum Power consumed	5W	
Supported Protocols	ArtNet	
	sACN	
	KiNET	
	ESP	
Output Protocols	WS2811	WS2812
	WS2812B	WS2813
	WS2815	SK6812
	TM1804	TM1812
	TM1814	APA-102
	APA-104	9PDOT (8 – 16bit)
Maximum Pixel count/output (RGBW)	512 RGBW pixels	
Maximum Pixel count/ output (RGB)	680 RGB pixels	
Maximum DMX footprint/output	2048 channels	
Connectors	2 x 4Pin Output phoenix	
	1 X 2Pin Power In	
	2 X RJ 45	
IP Rating	IP 20	
Operating Temperature	-10 °C to 60 °C	
Relative Humidity	5- 95% (non-condensing)	
Weight of device (In kg)	0.25 kg	
Dimensions (in mm)	103 (L) x 69 (W) x 58 (H)	

Due to continuous improvements and innovations of all ENTTEC products, specifications and features are subject to change without notice.

enttec.com

MELBOURNE AUS / LONDON UK / RALEIGH-DURHAM USA